

Article number: 12706000060110

Description: KLEE-coil 706 000 060.110
M6 Unhardened, zinc-pl. & chr. blue

Measures

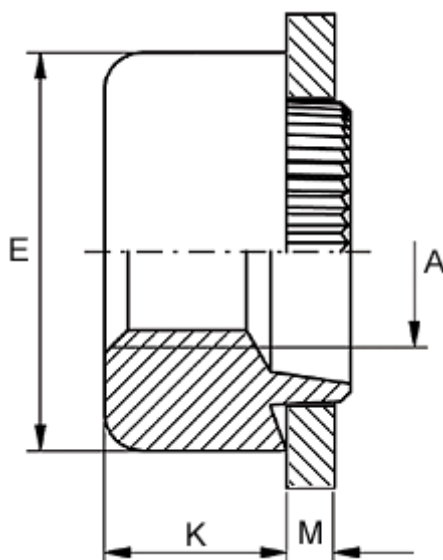

Female thread A	= M6
Height K	= 6.0
Outer diameter E	= 13.0
Plate thickness	= 1.4 to 1.6
Recommended bore diameter for extreme load	= 10.0
Recommended bore diameter for normal use	= 10.0